

# Panasonic

ideas for life

NEW

Pulse AC Method  
Area Ionizer

ER-X SERIES

CE  
Conforming to  
EMC Directive



## High-Speed, Wide Area Charge Removal

# Three charge removal modes for diverse application coverage

The **ER-X** series offers an airless charge removal capability to eliminate the need for compressed air in addition to low pressure and high speed compressed air based modes. Furthermore, it supports dual-head configurations for expanded application coverage.

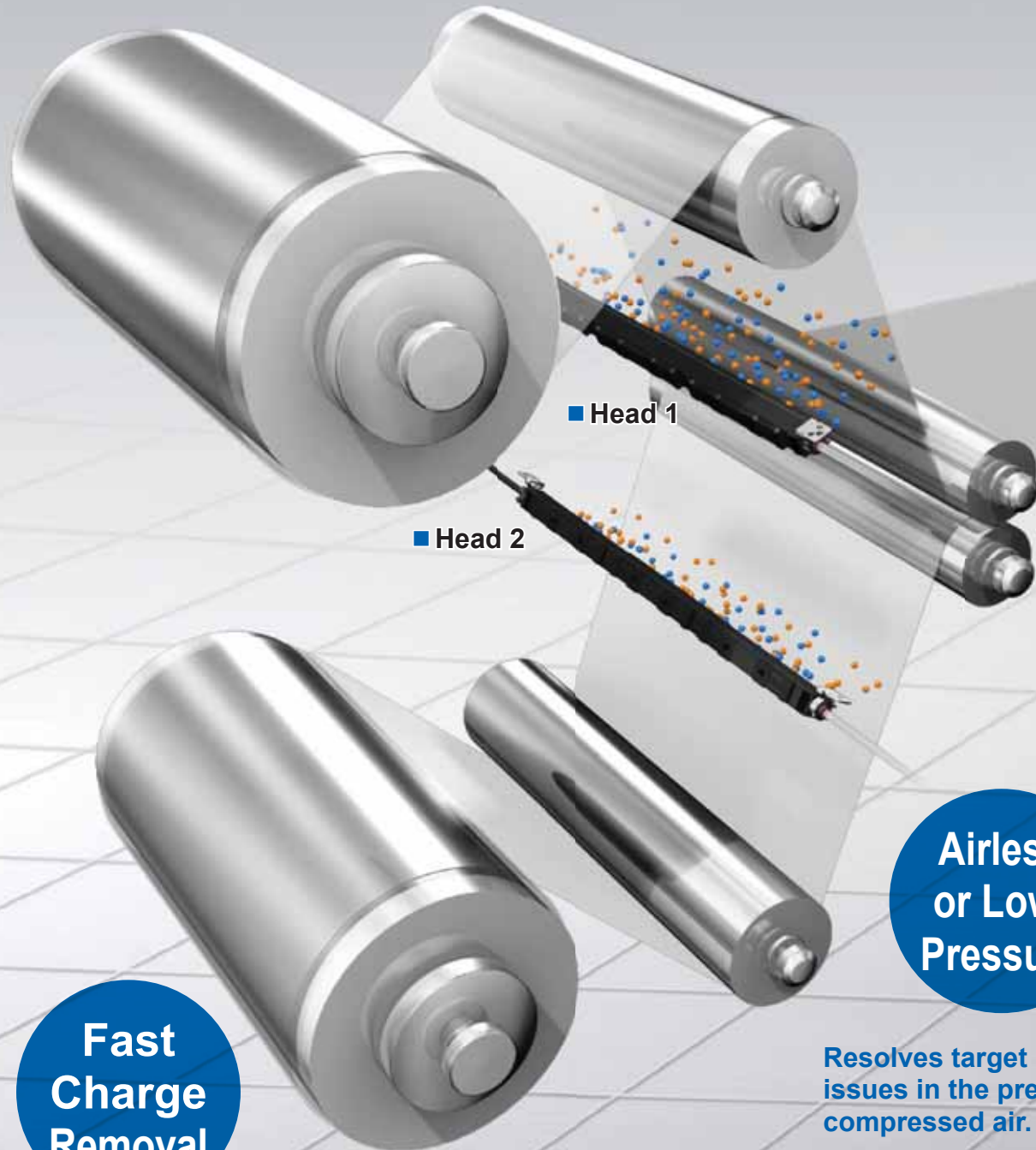

**Fast Charge Removal**

**Massive ion discharge when using air reduces charge removal time.**

By applying a compressed air source, the ion volume increases providing an improved tact time for substrate ionization. This makes the **ER-X** suitable for applications such as electronic paper and thin film solar cells, where charge removal time is directly linked to productivity.

**Airless or Low-Pressure**

**Resolves target movement issues in the presence of compressed air.**

The **ER-X** series works extremely well for charge removal applications. Precision substrates like laminated film and lead frames, as an example, may become unseated or shifted due to the presence of a compressed air source. The absence of compressed air during ionization facilitates smooth operation while efficiently removing surface charges.

## Dual Head Configuration for Enhanced Charge Area and Layout Expansion



■ Controller

Compressed air is supplied through a port opposite that of the power cable. This allows for the use of a single air line (using a T-branch) to supply multiple ionizers, while a single controller powers and manages two heads. The **ER-X** series allows for a combination of varied heads sizes for enhanced charge removal area and layout expansion.

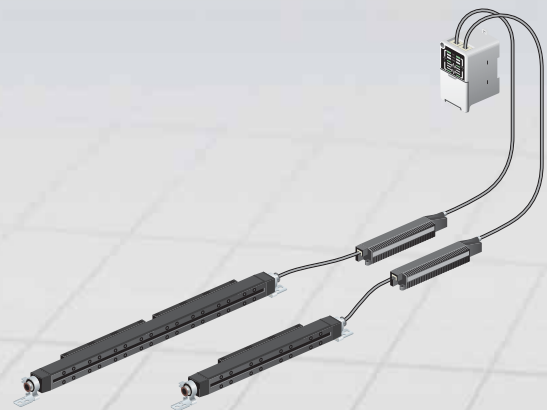

\* The two head units can be set to the same discharge frequency for synchronization or alternating frequencies between the two heads.

### Low-Pressure

(Air pressure:  
Less than 0.05MPa)

#### Prevents dust dispersion and cleanliness degradation!

The **ER-X** series can effectively remove surface charges with an air pressure of less than 0.05 MPa. With the advantage of minimal dust dispersion, it is suitable for charge removal in semiconductor, FPD (mobile panel), and other applications that require high degree of cleanliness. The presence of air also helps prevent adhesion of dust to the discharge needles, requiring less cleaning than in the airless charge removal mode.

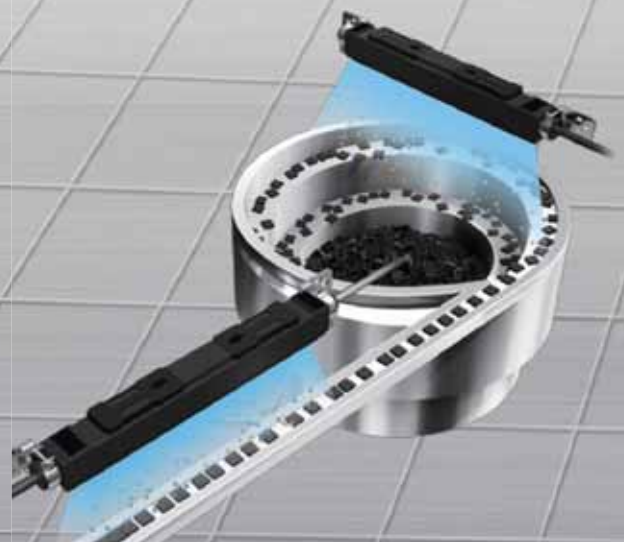

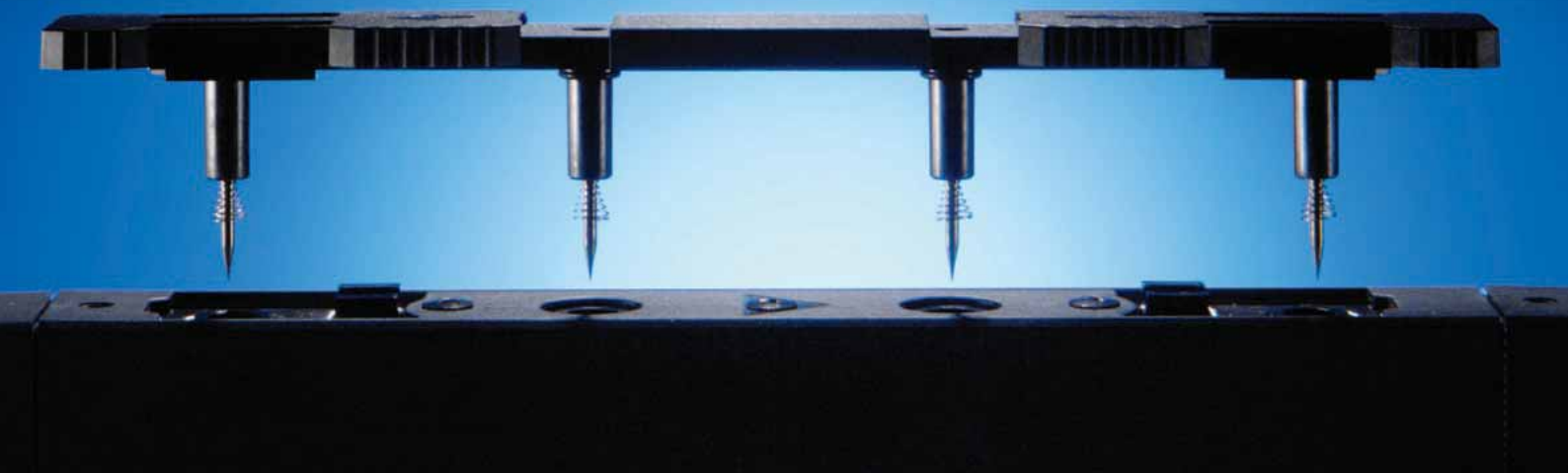

## Head variations

The **ER-X** series offers four head sizes so you can choose one that best fits your work piece.

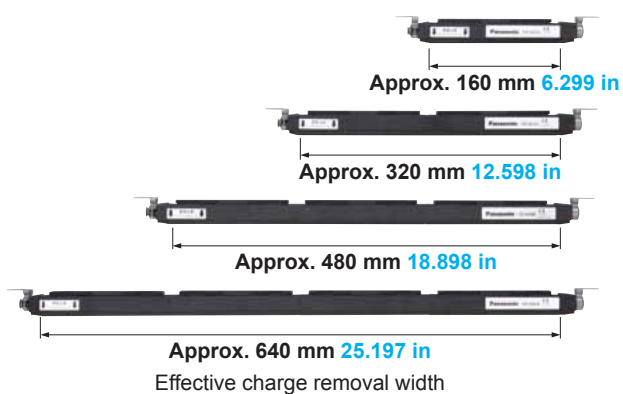

## Compact heads with a 360-degree angle adjustment mechanism

The **ER-X** series heads are compact in size (30 × 22 mm 1.181 × 0.866 in) and installable even in a narrow space. The heads can be rotated 360 degrees to enable charge removal area adjustment after installation.

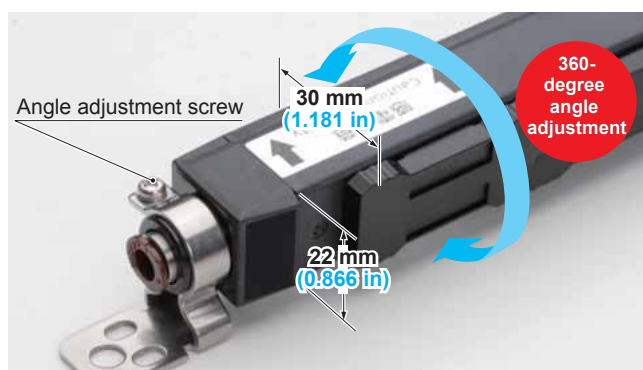

## Flat discharge surface for easy cleaning

The **ER-X** series heads have a flat discharge face, allowing effortless cleaning of the discharge needles and air outlets by simply brushing along the groove provided.

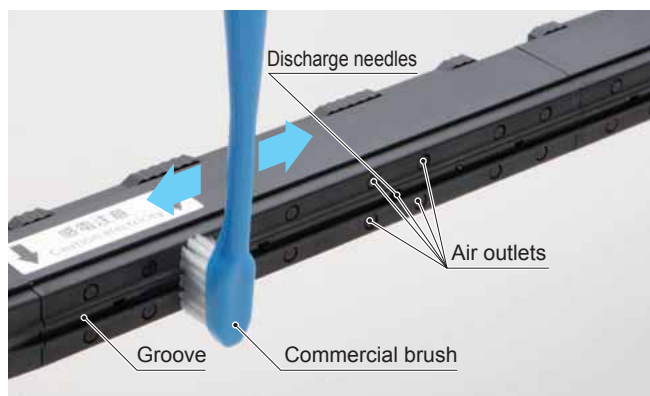

## Discharge needle unit for simple needle replacement

The removable discharge needle unit (including a set of four needles) substantially simplifies maintenance. To remove the unit, just slide it toward both ends as indicated by the arrows.

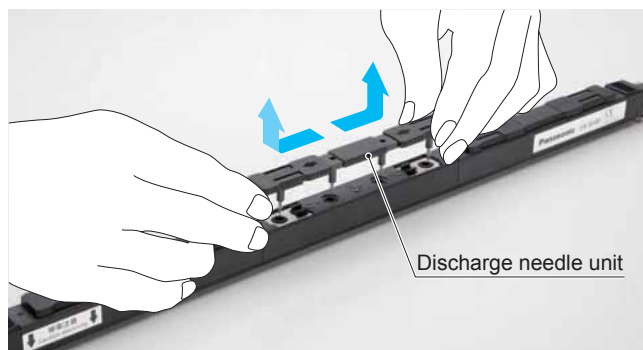

## Carefully designed to prevent contamination in manufacturing processes

In consideration of the manufacturing process (secondary cells etc.), the **ER-X** series heads neither use copper nor plate processing. This minimizes the risk of contamination with foreign substances.



## Pulse AC method for faster charge removal\*

\* Compared with conventional Panasonic models

The **ER-X** series has adopted the pulse AC method that alternately applies positive and negative voltages to each discharge needle. This enables generation and discharge of a large amount of ions, resulting in faster charge removal. In addition, the method offers variable discharge frequency/ion balance (between the positive (+) and negative (-) widths) and is useful for charge removal on different types of workpieces.

## High-speed charge removal on FPCs

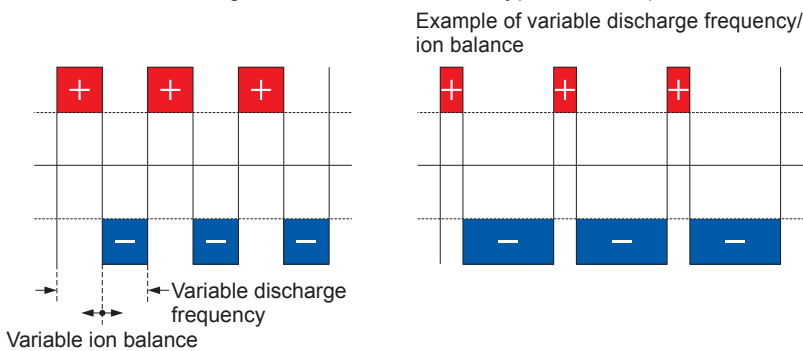
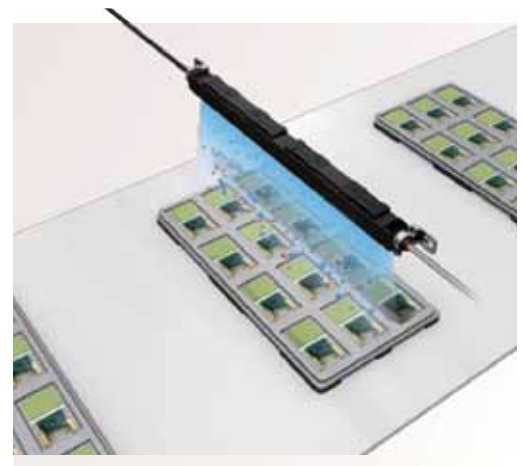

## Level meter for visual monitoring of the charge removal status

The **ER-X** series has two built-in monitoring modes. Ion Monitor mode detects and displays the amount of positive and negative ions being generated. The level meter can be used to visually identify degradation of ion production due to factors such as dust accumulation on the discharge needles. The Charge Monitor mode lets you quickly determine if the area around the head carries a positive or negative charge. These modes can be selected by using the display selector switch to determine how you would like to utilize the level meter.

### Ion monitor display

Displays the amount of ions being generated by the head. The current level of positive ions will be indicated on the "+" side; the current level of negative ions will be indicated on the "-" side.

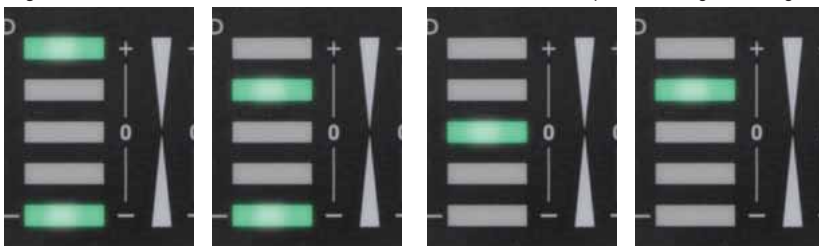

Normal ion generation

Unbalanced generation  
(The amount of positive ions decreased.)

Not charged

Charged  
(The area around the head carries a positive charge.)

### Charge monitor display





Displays how much the area around the head carries an electric charge. The level indicator moves up or down in the "+" or "-" range depending on the amount of the positive or negative charge.



## Automatic ion balance control

The **ER-X** series provides an automatic ion balance control mechanism that senses the amount of ions being generated (which changes according to environmental factors) and compensate for this deviation in the controller, thus maintaining a highly stable ion balance as an original operator setting.

**Heads** Head connection cable is not supplied with the head. Please order it separately.

Type	Appearance	Charge removal time (±1,000 V→±100 V)	Ion balance	Effective charge removal width	Model No.
Bar type		1 sec. approx. (Note 1)	±30 V or less (Note 1, 2)	160 mm <b>6.299 in</b> approx.	<b>ER-X016</b>
				320 mm <b>12.598 in</b> approx.	<b>ER-X032</b>
				480 mm <b>18.898 in</b> approx.	<b>ER-X048</b>
				640mm <b>25.197 in</b> approx.	<b>ER-X064</b>

Notes: 1) In condition of discharge distance 100 mm **3.937 in**, center of the product, discharge wavelength 50 Hz and no air supply.  
2) Ion balance is average of plus and minus. Also, the specification value is typical value in condition of less than ±10°C ambient temperature change, set the ion balance after 30 minutes of the discharge starting, switching on the ion balance control function.

**Controller** Power cable is not supplied with the controller. Please order it separately.

Type	Appearance	Model No.	Number of heads connected	Output
Standard type		<b>ER-XC02</b>	Max. 2 units	PhotoMOS relay

**Head connection cable** Head connection cable is not supplied with the head. Please order it separately.

Appearance	Model No.	Description
	<b>ER-XCCJ2H</b>	Length: 2 m <b>6.562 ft</b> , Net weight: 80 g approx.
	<b>ER-XCCJ5H</b>	Length: 5 m <b>16.404 ft</b> , Net weight: 190 g approx.

Cabtyre cable with both connector

## OPTIONS

Designation	Model No.	Description
Power cable	<b>ER-XCC2</b>	Length: 2 m <b>6.562 ft</b> , Net weight: 80 g approx.
	<b>ER-XCC5</b>	Length: 5 m <b>16.404 ft</b> , Net weight: 190 g approx.
AC adapter	<b>ER-XAPS-EX</b> (Note)	IN: 100 to 240 V AC, 50 / 60 Hz OUT: 24 V DC, 1.5 A Ambient temperature: 0 to +40 °C <b>+32 to +104 °F</b> Ground wire: 3.7 m <b>12.139 ft</b>
	<b>ER-XAPS</b>	AC cable: 1 pc., Cable length 1.8 m <b>5.906 ft</b> , Rating 125 V AC (Note) Wiring connector terminals: 6 pcs.
AC cable	<b>CN-ACCN-C2</b>	AC cable (conforming to CCC), Length: 2 m <b>6.562 ft</b>
	<b>CN-ACKR-C2</b>	AC cable (conforming to KTL), Length: 2 m <b>6.562 ft</b>
Discharge needle unit	<b>ER-XANT</b>	Unit with replacement tungsten needles: 1 pc.

### Power cable

- **ER-XCC□**



### AC adapter

- **ER-XAPS-EX**



- **ER-XAPS**



### Discharge needle unit

- **ER-XANT**



Note: Rating of the AC cable is 125 V AC. In case using at more than 125 V, prepare a proper cable by yourself or purchase our optional cable **CN-ACCN-C2** or **CN-ACKR-C2**. And, the AC cable is not enclosed with **ER-XAPS-EX**.

## SPECIFICATIONS

### Heads

Item	Type	Head			
	Model No.	ER-X016	ER-X032	ER-X048	ER-X064
Effective charge removal width		160 mm <b>6.299 in</b> approx.	320 mm <b>12.598 in</b> approx.	480 mm <b>18.898 in</b> approx.	640 mm <b>25.197 in</b> approx.
Charge removal time		1 second or less (Note 1)			
Ion balance		±30 V or less (Note 1, 2)			
Discharge method		Pulse AC method			
Discharge output voltage		7,000 V approx.			
Ozone generation		0.01 ppm or less			
Maximum air pressure		0.5 MPa			
Applicable fluid		Air (dried clean air) (Note 3)			
Ambient temperature		0 to +50 °C <b>+32 to +122 °F</b> (No dew condensation), Storage: -10 to +65 °C <b>+14 to +149 °F</b>			
Ambient humidity		35 to 65 % RH, Storage: 35 to 85 % RH			
Vibration resistance		10 to 55 Hz frequency, 0.75 mm <b>0.030 in</b> amplitude in X, Y and Z directions for two hours each			
Shock resistance		100 m/s <sup>2</sup> acceleration (10 G approx.), in X, Y and Z directions for three times each			
Enclosure grounding method		Floating			
Material		Main unit enclosure: PPS, Stainless steel (SUS) Head mounting bracket: Stainless steel (SUS), Discharge needle: Tungsten			
Net weight		410 g approx.	530 g approx.	650 g approx.	780 g approx.

Notes: 1) In condition of discharge distance 100 mm **3.937 in**, center of the product, discharge wavelength 50 Hz and no air supply.  
 2) Ion balance is average of plus and minus. Also, the specification value is typical value in condition of less than ±10 °C ambient temperature change, set the ion balance after 30 minutes of the discharge starting, switching on the ion balance control function.  
 3) The dried clean air is dried (dew point: equivalent of -20 °C) and filtered (mesh-size: equivalent of 0.01 µm) air.

### Controller

Item	Type	Controller
	Model No.	ER-XC02
Number of heads connected		Maximum 2 units
Supply voltage		24 V DC ±10 %
Current consumption		450 mA or less when connecting 1 heads, 800 mA or less when connecting 2 heads
Indicator		Displays status of Head 1 and 2
	DSC (Discharge)	Green LED (lights up when discharging)
	CHECK	Orange LED (lights up when dirt, wear, etc. of the discharge needle is detected)
	ERROR	Red LED (lights up when abnormal discharge is detected)
	Level meter	Green LED (5 levels, lights up depending on amount of the charge or ion generation)
Output		PhotoMOS relay output
ALARM		• Maximum load current: 100 mA
ERROR		• Applied voltage: 30 V DC or less (between output-output common)
COM (Common)		• Residual voltage: 1.5 V or less (at load current of 100 mA)
Output operation		ALARM: ON when dirt or wear of the discharge needle is detected; OFF when operation is normal. ERROR: OFF when abnormal discharge is detected; ON when operation is normal.
Short-circuit protection		Incorporated (automatic reset type)
Discharge control input (DSC OFF)		Discharge allowed: Open, Discharge halt: 24 V or 0 V shorted
Ambient temperature		0 to +50 °C <b>+32 to +122 °F</b> (No dew condensation), Storage: -10 to +65 °C <b>+14 to +149 °F</b>
Ambient humidity		35 to 65 % RH, Storage: 35 to 85 % RH
Voltage withstandability		1,000 V AC for one min. between all supply terminals connected together and enclosure
Insulation resistance		20 MΩ, or more, with 250 V megger between all supply terminals connected together and enclosure
Vibration resistance		10 to 150 Hz frequency, 0.75 mm <b>0.030 in</b> amplitude in X, Y and Z directions for two hours each
Shock resistance		100 m/s <sup>2</sup> acceleration (10 G approx.) in X, Y and Z directions for three times each
Enclosure grounding method		Floating
Material		Enclosure: ABS
Weight		130 g approx.
Accessories		Power supply / I/O connector: 1 set (Housing 5557-10R, Terminal 5556TL [manufactured by Molex Inc.]) Ground wire (3.7 m <b>12.139 ft</b> approx.): 1 pc.

Measured using a 150 × 150 mm 5.906 × 5.906 in CPM (charge plate monitor). (At center of CPM)

### Common

Air flow

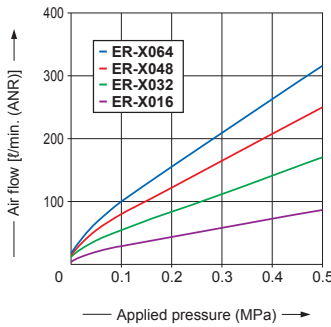

Correlation between charge removal distance and charge removal time (50 Hz)

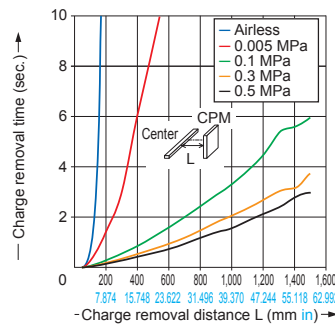

Correlation between charge removal distance and charge removal time (10 Hz)

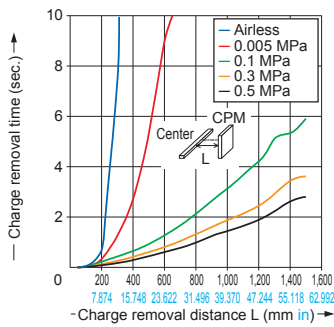

Correlation between charge removal distance and charge removal time (1 Hz)

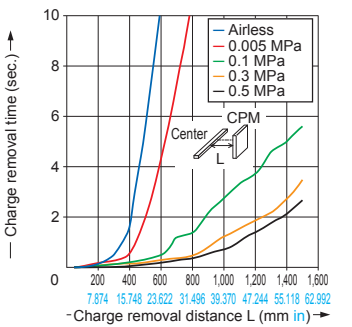

### Common

Charge removal field (vertical direction, airless, 50 Hz)

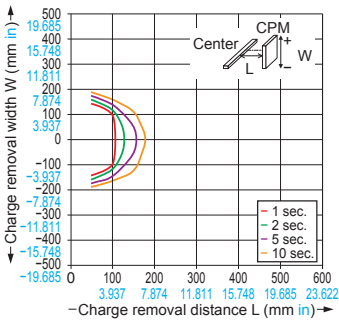

Charge removal field (vertical direction, airless, 10 Hz)

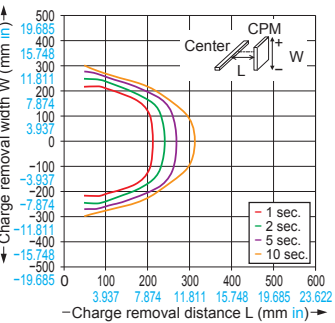

Charge removal field (vertical direction, airless, 1 Hz)

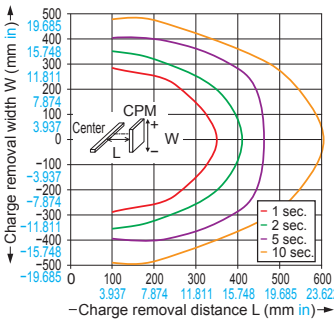

Charge removal field (vertical direction, 0.005 MPa, 50 Hz)

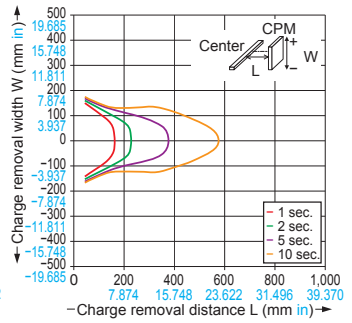

### Common

Charge removal field (vertical direction, 0.005 MPa, 10 Hz)

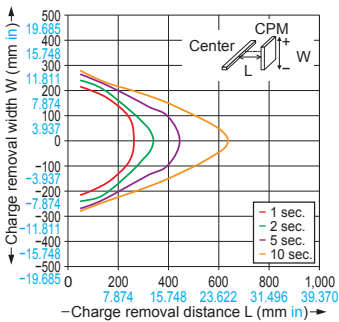

Charge removal field (vertical direction, 0.005 MPa, 1 Hz)

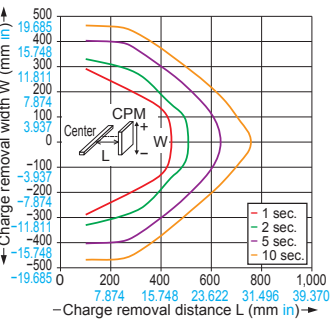

Charge removal field (vertical direction, 0.5 MPa, 50 Hz)

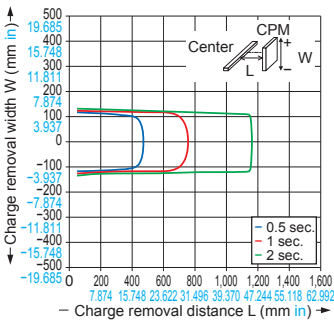

Charge removal field (vertical direction, 0.5 MPa, 10 Hz)

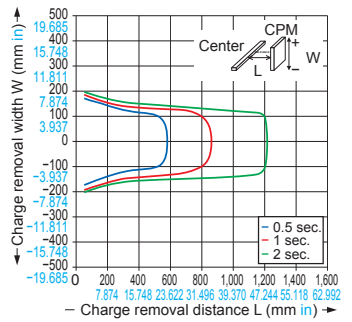

### Common

Charge removal field (vertical direction, 0.5 MPa, 1 Hz)

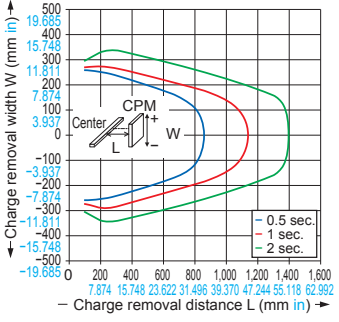

### ER-X032

Charge removal field (horizontal direction, airless, 50 Hz)

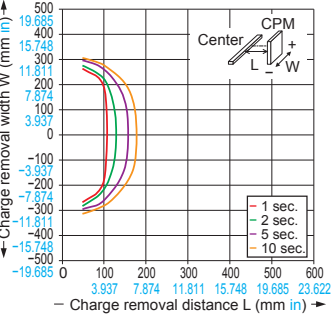

Charge removal field (horizontal direction, airless, 10 Hz)

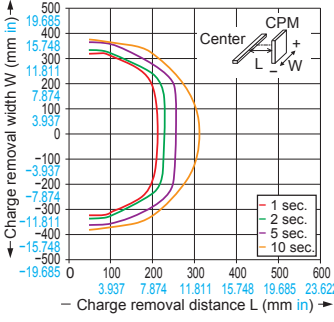

Charge removal field (horizontal direction, airless, 1 Hz)

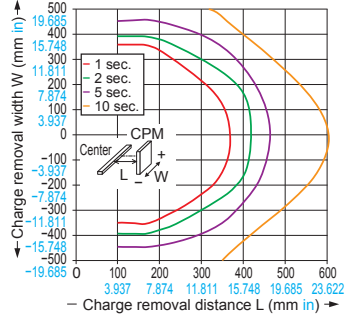



**CHARGE REMOVAL CHARACTERISTICS (TYPICAL)**

Please contact our office for details on data that is not listed here.

Measured using a 150 × 150 mm 5.906 × 5.906 in CPM (charge plate monitor). (At center of CPM)

**ER-X032**

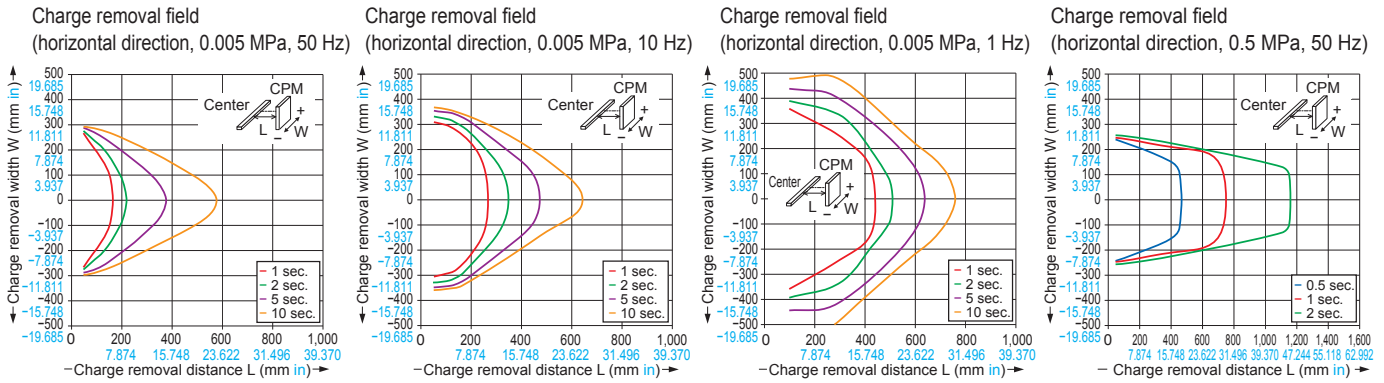

**ER-X032**

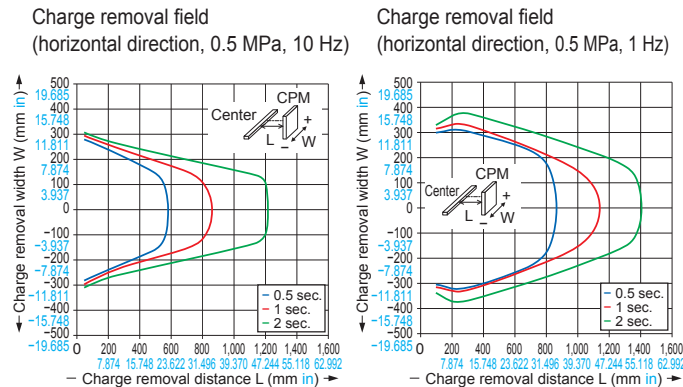

**ER-X064**

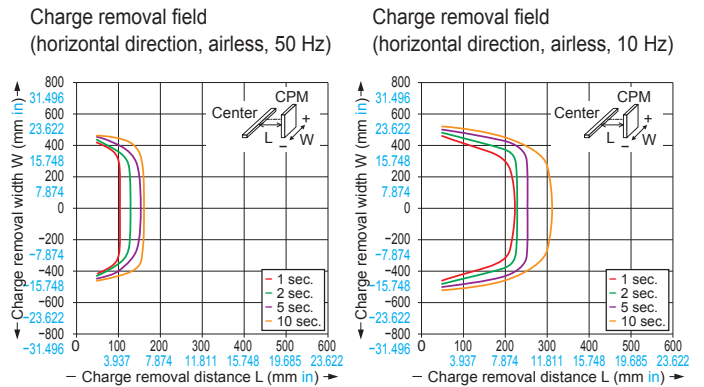

**ER-X064**

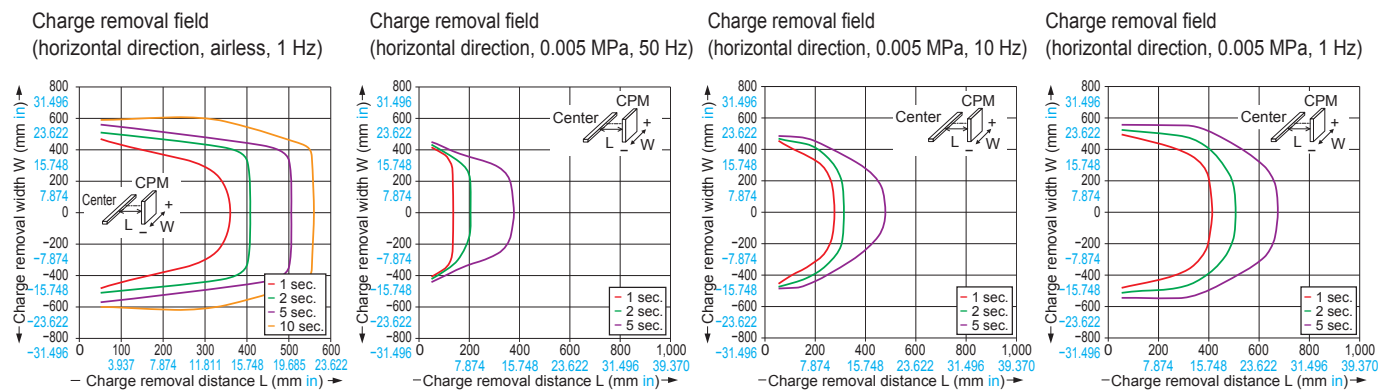

**ER-X064**

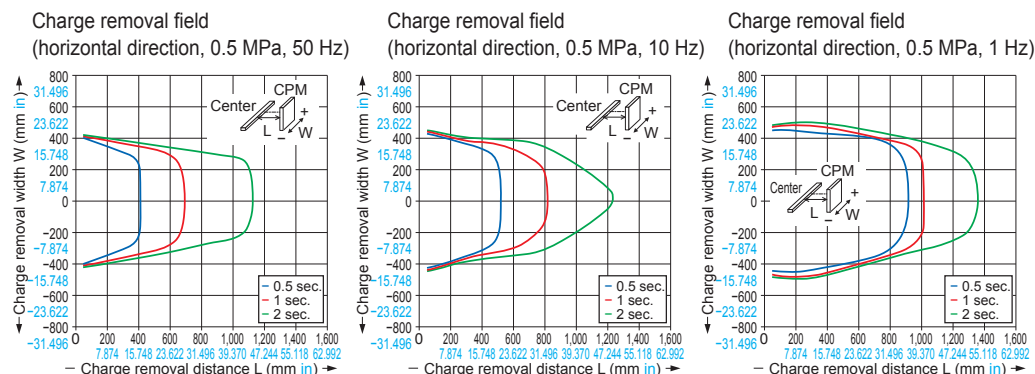

### Power connector pin arrangement



(Front view)

Housing: 5569-10A  
[Manufactured by Molex Inc.]

Terminal No.	Terminal name	Color code
1	0 V	Blue
2	COM(-)	—
3	Discharge control input	Pink
4	COM(OUT)	Violet
5	F.G. terminal	Green/Yellow
6	24 V	Brown
7	COM(+)	—
8	—	White
9	Alarm output	Orange
10	Error output	Black

Note: Wire colors are colors of power supply cable of option.

### When connecting the output to negative common

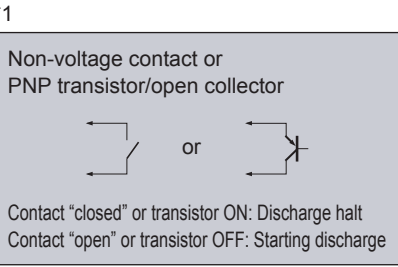
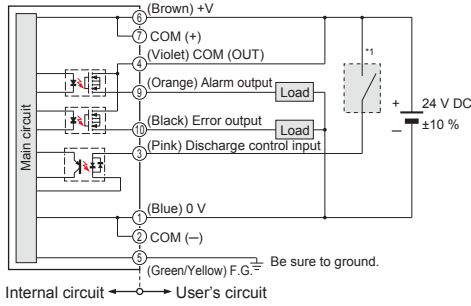

### When connecting the output to positive common

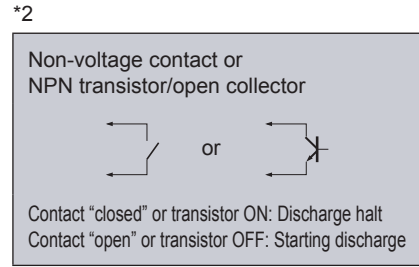
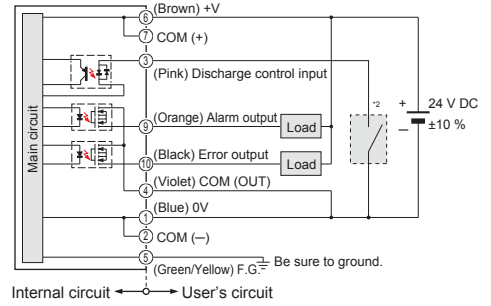

- Notes: 1) Be sure to ground the F.G. terminal. If F.G. terminal is not connected properly, it may cause electric shock.  
2) To stop discharge, turn ON the discharge control input for 20 ms or longer. To start discharge, turn OFF (open) the discharge control input. Discharge will start in 20 ms.

## PRECAUTIONS FOR PROPER USE



- Never use this product in a device for personnel protection.
- In case of using devices for personnel protection, use products which meet laws or standards, such as OSHA, ANSI or IEC etc., for personnel protection applicable in each region or country.
- Do not use this product in places where there may be a danger of flammable or combustible items being present.
- To prevent electric shock and to conduct proper discharge, be sure to ground a frame ground (F.G.) terminal of a controller.
- Do not place hands near the discharge needle. Doing so may cause electric shock.
- Since the tip of the discharge needle is sharp, take sufficient care in handling the discharge needle, or injuries may result.
- The high-voltage cable between the head and the high-voltage unit must be fixed and the minimum bend radius is R30 mm **R1.181 in** or more. In case of using at the bend radius R30 mm **R1.181 in** or less and using at moving part may cause fire and break down, etc. of the high-voltage cable.
- Clean the discharge needle regularly (about once a week). Otherwise, optimum charge removal performance may not be achieved, and accidents or operating problems may occur.
- If this product is used in a confined space, ozone emitted from this product may be detrimental. Be sure to provide ventilation.
- Do not direct ionized air toward the face. Ozone may cause irritation to places such as the nose and throat.

- Notes: 1) Be sure to ground the equipment housing onto which the head is mounted.  
2) The distance between the head and the charge removing object should be 30 mm **1.181 in** or more. If the static buildup of the charge removing object is 30 kV or more, set the distance to 50 mm **1.969 in** or more.  
3) If there is metal near the head or between the head and the charge removing object, ion is absorbed, hindering appropriate static removal. Install the head under the following installation condition.  
4) In case using the side mounting, the discharge frequency should be 10 Hz or more.

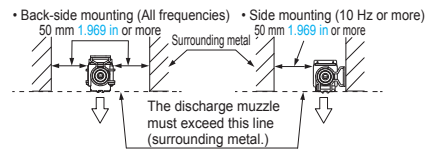

- 5) When installing two or more heads set the same frequency and keep the distance as below. In face to face or parallel using different frequency, keep the distance between the heads 400 mm **15.748 in** or more.

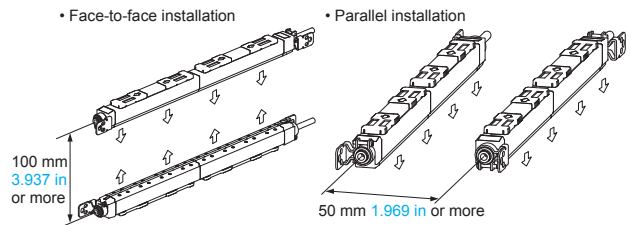

### High-voltage unit installation

- Using 2 M4 screws, fasten the unit with tightening torque of 1.2 N·m or less.

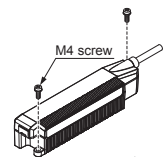

- Notes: 1) Do not place any objects on top of the high-voltage unit.  
2) When using multiple heads, keep the distance of at least 10 mm **0.394 in** between the high-voltage units.

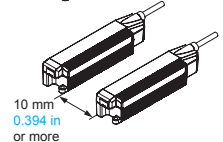

## PRECAUTIONS FOR PROPER USE

### Controller installation

- Mount the controller on a 35 mm **1.378 in** wide DIN rail or using M4 screws.

#### <When mounting on a DIN rail>

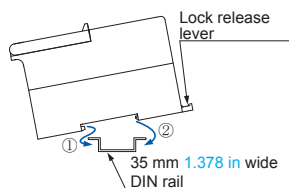

- Pull the lock release lever to remove this product from the DIN rail.

#### <When mounting using M4 screws>

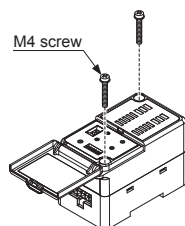

- The tightening torque should be 1.2 N•m or less.

### PIPING

- Air supplied to this product will reduce contamination of the discharge needle and improve the charge removal speed.
- The outer diameter of the air tube to fit to the air inlet portion of this product should be  $\varnothing 6$  mm  **$\varnothing 0.236$  in**.
- Make sure that clean air (air containing no water, no oil and no dust) should be supplied.
- Since the pressure will drop when the air piping from the main pressure supply is extended or pneumatic components (e.g., needle valve, speed controller, mini filter) are added, keep an eye on the pressure supply to the ionizer making sure it is not in short supply. For the pneumatic components, select those that can accommodate the air supply flow rate.

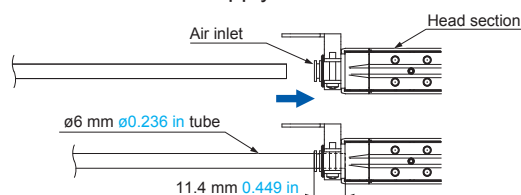

Note: After inserting the tube into the joint of this product, always make sure that the tube is all the way in and securely inserted. Insufficient tube insertion will cause air leakage.

## DIMENSIONS (Unit: mm in)

The CAD data in the dimensions can be downloaded from our website.

### ER-X□

### Head

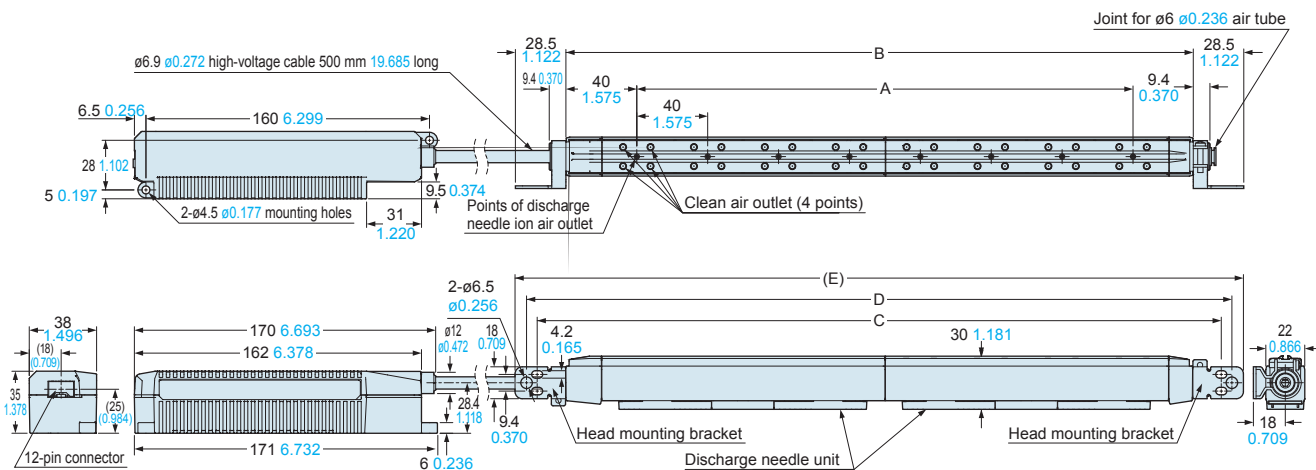

#### Details of a head mounting bracket

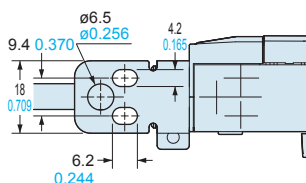

Model No.	A	B	C	D	(E)
ER-X016	120 4.724	194 7.638	226 8.898	238 9.370	251 9.882
ER-X032	280 11.024	354 13.937	386 15.197	398 15.669	411 16.181
ER-X048	440 17.323	514 20.236	546 21.496	558 21.969	571 22.480
ER-X064	600 23.622	674 26.535	706 27.795	718 28.268	731 28.780

### ER-XC02

### Controller

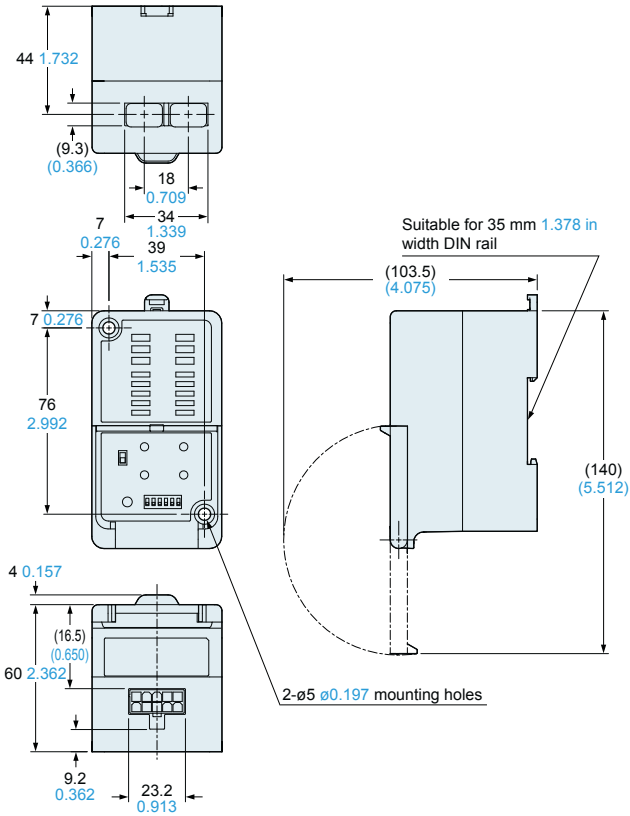

### ER-XCCJ□H

### Head connection cable

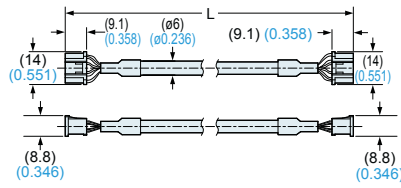

• Length L

Model No.	Length L
ER-XCCJ2H	2,000 78.740
ER-XCCJ5H	5,000 196.850

### ER-XCC□

### Power cable (Optional)

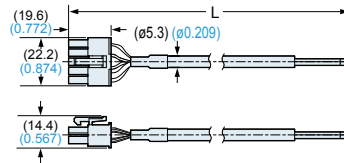

• Length L

Model No.	Length L
ER-XCC2	2,000 78.740
ER-XCC5	5,000 196.850

### ER-XAPS(-EX)

### AC adapter (Optional)

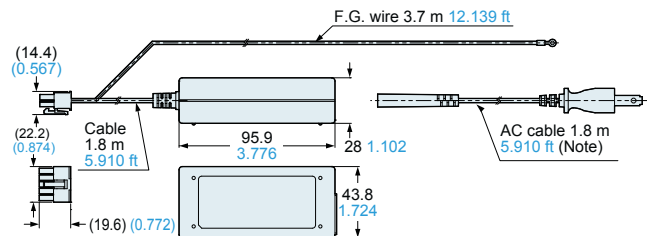

Note: The AC cable is not enclosed with ER-XAPS-EX.