

**BEFORE USE ....**

Thank you for choosing M-System. Before use, please check contents of the package you received as outlined below.

If you have any problems or questions with the product, please contact M-System's Sales Office or representatives.

**■ PACKAGE INCLUDES:**

- Discrete output module.....(1)
- Terminating resistor (110Ω, 0.25W).....(1)

**■ MODEL NO.**

Confirm that the model number described on the product is exactly what you ordered.

**■ INSTRUCTION MANUAL**

This manual describes necessary points of caution when you use this product, including installation, connection and basic maintenance procedures.

**POINTS OF CAUTION**

**■ NONINCENDIVE APPROVAL OPTION**

- This equipment is suitable for use in Class I, Division 2, Groups A, B, C, D or Non-Hazardous Locations only.
- **WARNING!** – Explosion Hazard –
- Substitution of any component may impair suitability for Class I, Division 2.
- **WARNING!** – Explosion Hazard –
- **DO NOT** disconnect while the circuit is live or unless the area is known to be free of ignitable concentrations.
- Temperature Code of this equipment is T5 and the Maximum Ambient Temperature is 55°C (Surrounding Temperature inside the fire enclosure).

**■ CONFORMITY WITH UL APPROVAL**

- This equipment is suitable for use in Installation Category II and in a Pollution Degree 2 environment.
- Altitude up to 2000 meters.
- This equipment must be mounted inside a suitable fire enclosure.
- This equipment is to be supplied by a Class 2 power supply.

**■ CONFORMITY WITH EU DIRECTIVES**

- The equipment must be mounted inside the instrument panel of a metal enclosure.
- The actual installation environments such as panel configurations, connected devices and connected wires may affect the protection level of this unit when it is integrated in a panel system. The user may have to review the CE requirements in regard to the whole system and employ additional protective measures to ensure CE conformity.
- Install lightning surge protectors for those wires connected to remote locations. Choose a surge protector with its maximum surge voltage 40V or less between lines. Recommended M-System model: MDP-D24.

**■ POWER INPUT RATING & OPERATIONAL RANGE**

- Locate the power input rating marked on the product and confirm its operational range as indicated below:  
24V DC rating: 24V ±10%, approx. 70mA

**■ GENERAL PRECAUTIONS**

- Before you remove the unit or mount it, turn off the power supply and output signal for safety.

**■ ENVIRONMENT**

- Indoor use.
- When heavy dust or metal particles are present in the air, install the unit inside proper housing with sufficient ventilation.
- Do not install the unit where it is subjected to continuous vibration. Do not subject the unit to physical impact.
- Environmental temperature must be within -10 to +55°C (14 to 131°F) with relative humidity within 30 to 90% RH in order to ensure adequate life span and operation.

**■ WIRING**

- Do not install cables close to noise sources (relay drive cable, high frequency line, etc.).
- Do not bind these cables together with those in which noises are present. Do not install them in the same duct.

**■ AND ....**

- The unit is designed to function as soon as power is supplied, however, a warm up for 10 minutes is required for satisfying complete performance described in the data sheet.

# COMPONENT IDENTIFICATION

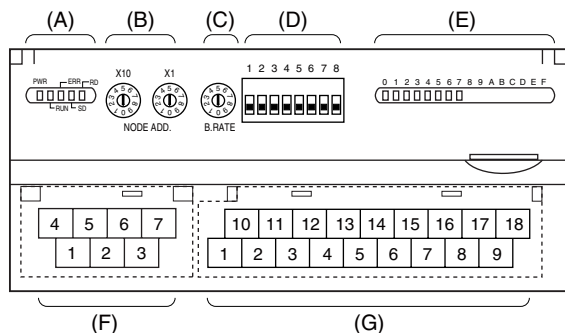

- (A) Status Indicator LED
- (B) Node Address Setting Rotary SW
- (C) Baud Rate Setting Rotary SW
- (D) Operating Mode Setting DIP SW (SW1)
- (E) Discrete I/O Status Indicator LED
- (F) Modbus, Power Supply Terminals
- (G) Output Terminals

## ■ STATUS INDICATOR LED

ID	COLOR	FUNCTION
PWR	Red	Turns on when the internal 5V is supplied normally.
RUN	Red	Turns on when the data is received normally.
ERR	Red	Turns on when the received data is abnormal. Blinks when setting is abnormal.
SD	Red	Turns on when the module is transmitting.
RD	Red	Turns on when the module is receiving.

## ■ NODE ADDRESS

Node Address is selected between 1 and 99 in decimal. The left switch determines the tenth place digit, while the right switch does the ones place digit of the address.

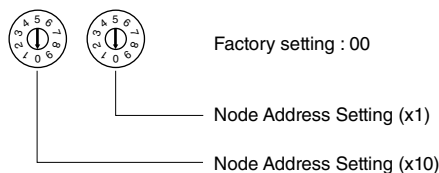

## ■ BAUD RATE

Baud Rate is selected with the rotary switch.

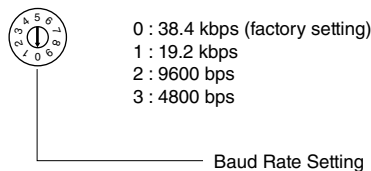

## ■ EXTENSION MODULE

Combinations with all extension modules are selectable.

## ■ OPERATING MODE

(\*) Factory setting

### • Extension (SW1-1, 1-2)

SW1-1	SW1-2	EXTENSION
OFF	OFF	No extension (*)
ON	OFF	Discrete input, 8 or 16 points
OFF	ON	Discrete output, 8 or 16 points

### • Output at the Loss of Communication (SW1-4)

SW1-4	OUTPUT AT THE LOSS OF COMMUNICATION
OFF	Reset the output (turned off)
ON	Hold the output (*) (maintains the last data received normally)

Note : Be sure to set unused SW1-3 and 1-5 through 1-8 to OFF.

## ■ DISCRETE OUTPUT STATUS INDICATOR LED

LED indicators show the signal status.

ON : LED ON

OFF : LED OFF

## ■ POWER SUPPLY, MODBUS TERMINAL ASSIGNMENT

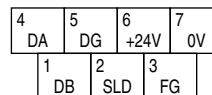

NO.	ID	FUNCTION, NOTES
1	DB	----
2	SLD	Shield
3	FG	FG
4	DA	----
5	DG	----
6	+24V	Power input (24V DC)
7	0V	Power input (0V)

## ■ OUTPUT TERMINAL ASSIGNMENT

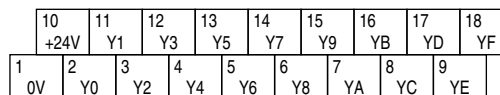

NO.	ID	FUNCTION	NO.	ID	FUNCTION
1	0V	0V (common)	10	+24V	24V DC
2	Y0	Output 0	11	Y1	Output 1
3	Y2	Output 2	12	Y3	Output 3
4	Y4	Output 4	13	Y5	Output 5
5	Y6	Output 6	14	Y7	Output 7
6	Y8	Output 8	15	Y9	Output 9
7	YA	Output 10	16	YB	Output 11
8	YC	Output 12	17	YD	Output 13
9	YE	Output 14	18	YF	Output 15



## MASTER CONNECTION

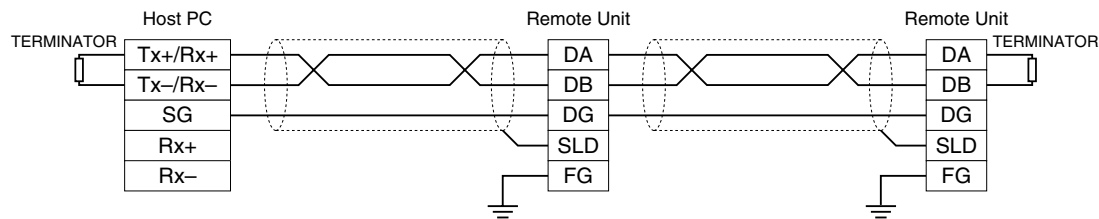

Be sure to connect the terminating resistor included in the product package to the unit at both ends of transmission line. The terminator must be connected across DA and DB. The Host PC can be located other than at the extreme ends of transmission line.

## CONFORMITY WITH CE MARKING

### ■ CE MARKING

CE marking requires to integrate safety regulations existed in each country in EU territory and to secure smooth distribution of products of which safety is guaranteed. It is mandatory by law that products distributed and sold in EU territory to have CE mark which shows that the product conforms with the requirements of EU Directive. Each EU Directive describes the scope of apparatuses to which that EU Directive is applied. M-System's R7M must conform with EMC Directive. Each Directive states only basic requirements. In order to mark the CE on an assembled machinery equipment, its manufacturer needs to check the overall conformity with Directives applicable to it.

### ■ WARNINGS AND CAUTIONS WHEN INSTALLING THE R7M

The R7M needs to be installed in a control panel. This is effective not only to ensure general safety but also to contain noise emissions by the R7M inside the control panel. We conduct a series of testing to see that the product conforms to EMC Directive while it is installed in the control panel.

Warning and cautions when installing R7M are stated below.

- Use control panels with an internal panel plate, both made of metal, when installing the R7M.
- Make sure to adequately ground the control panel and the internal panel plate with a thick cable to maintain low impedance at high frequency.
- Use shielded cables for the signals taken out of the control panel.
- Choose a thick and short cable to ground the FG terminal of the R7M module to the internal panel plate of the control panel.
- Note: If electromagnetic radiation disturbance increases by grounding the FG terminal, remove the grounding.
- When painting the internal plate of the control panel, apply masking to expose metal surface to secure conductivity at the sections where the following parts are attached:
  - Bolts attaching the internal panel to the control panel
  - Ground for the FG of the R7M module
  - Earth clamp on the shielded cable
- Noise emissions inside the control panel might leak through its openings. Design them as small as possible. Recommended diameter is 10 cm or less.

### Supplement:

Additional measures may be taken depending upon actual installation sites. These points of cautions are illustrated in the next page.

- Prevent noise leakage by wrapping cables using shield covers, shield tubes and flexible conduits etc. if noise leaks through the cable outlet.
- Use an electromagnetic shield gasket and block up the gap between the control panel cabinet and its cover, if noise leaks through it.
- Connecting the internal panel plate and the cover of the control panel to the main cabinet using an earth strap may be effective to strengthen the grounding.
- Electromagnetically shielded control panel cabinet is effective for shielding.

• Points of cautions applicable when installing the R7M Series

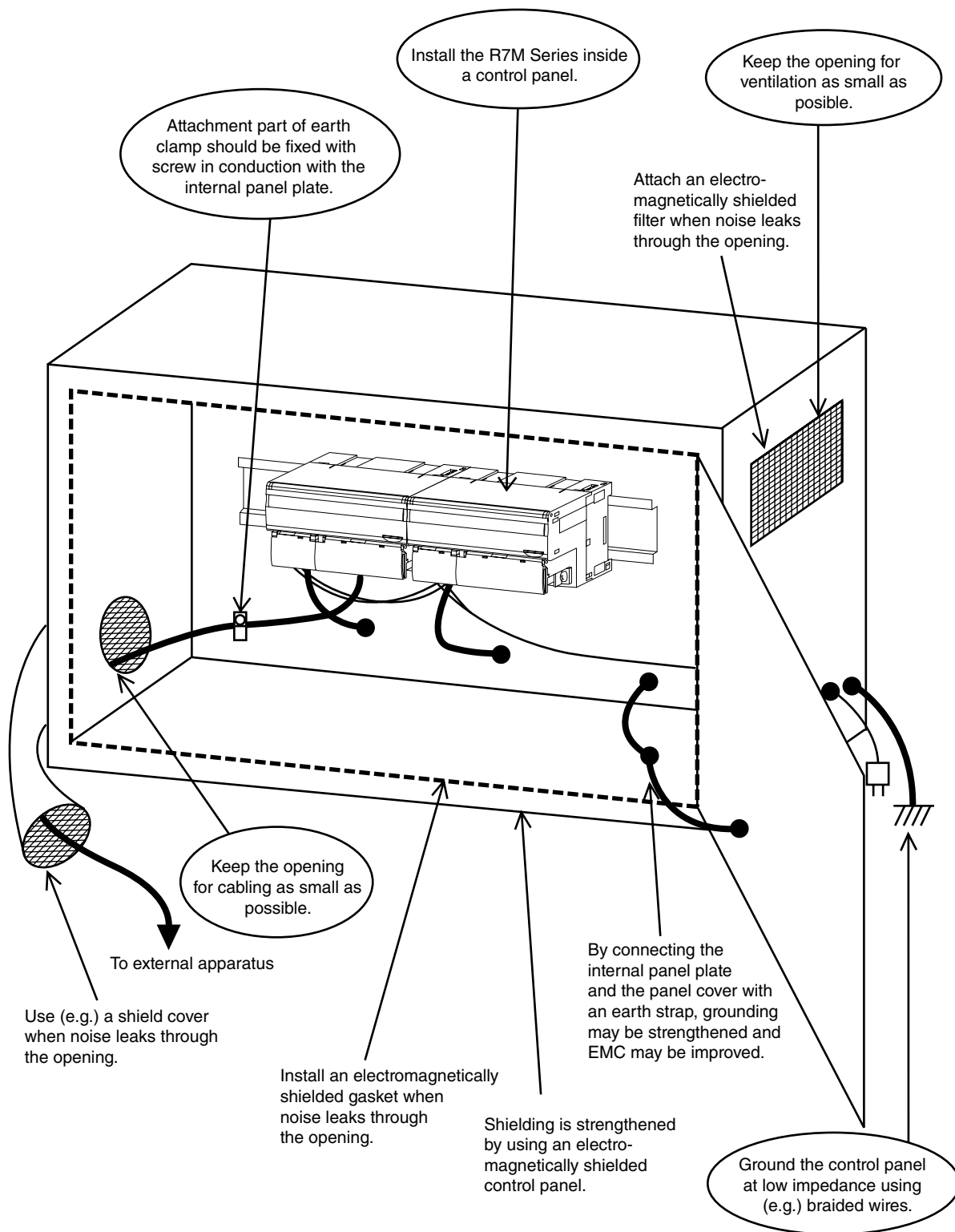

## ■ WARNINGS AND CAUTIONS WHEN LAYING CABLES

Signal cables connected to the R7M contain high-frequency components. Since these cables have the same effect as an antenna, they emit these high-frequency components to the external space as noise or overlaps noise from the external space on themselves.

Cables with shielding should be used for the signal line due to the above reason.

EMC conformance test is conducted in the condition that shielded cables and earth clamps are used with the R7M.

Warning and cautions when laying cables are stated below. These points of cautions are illustrated in the next page.

- Use shielded cables for those signal cables installed out of the control panel and for thermocouple and RTD extension wires.
- All the network cables connected to R7M should be shielded.
- Use shielded cables for network communication.
- Expose the shield at a part of the cable cover, clip it with an earth clamp, and ground it to the internal panel of the control panel. A drain wire connected to the panel in a pig-tail form cannot maintain low impedance against high-frequency noise, thus grounding (noise shielding) in this form will not be effective.

### Supplement:

Additional measures may be taken depending upon actual installation sites. These points of cautions are illustrated in the next page.

- Keep cables as short as possible. It prevents noise emissions from the cables and noise overlapping to the cables.
- Attach a ferrite core to reduce noise impact to the signal cables susceptible to the noise. Ferrite core can be attached close to the cable outlet of the control panel or close to the I/O terminal or connector, whichever is more effective. Also, the impact might be reduced by winding the cable around the ferrite core for extra turns or attaching multiple ferrite cores.
- Keep cables which are easily affected by noise away from those which can be a noise source.

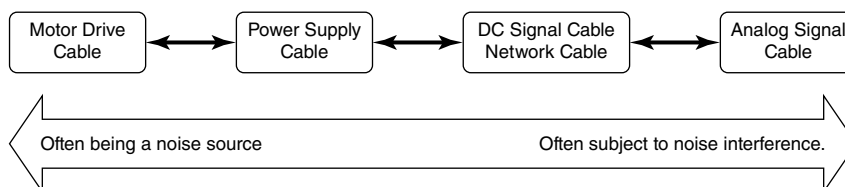

In the following are examples of effective ways to lay cables separately:

- Keeping physical distance (farther than 20 cm from motor drive cables, farther than 10 cm for other groups).
- Dividing off by a grounded metal plate
- Grouping into separate grounded metal pipes or cable shields.

Wires on each side of a filter should not be too close to each other. Noise could ride onto the other side of cable.

Extra attention needs to be paid at the following parts.

- Noise filter that is enclosed in power cables.
- Ferrite core that is attached to signal cables.
- Noise limiting circuit (surge quenching circuit, transient absorber circuit, etc.) that is enclosed in signal cables.

• Points of cautions applicable when wiring the R7M Series

